

# Accuride®

## MODEL 3832ETR/3832EHDTR



Touch Release and Heavy-Duty Touch Release  
Stays closed, push to open  
Optional Rear Face Frame Brackets

**APPLICATIONS:** For use in wood pedestals, dresser, and desk drawers, casework, residential and kitchen cabinetry. **Heavy Duty Touch Release provides stronger stay-closed feature. Not intended for lateral file\* drawer applications. Use for side mount only. This product is covered by U.S. and various foreign patents issued and/or pending.**

## 3832ETR/EHDTR QUICK REFERENCE BOX

Side Space: 1/2"+1/32"X2  
Lengths: 12"-28"  
Overall Slide  
Dimensions: 1.80X1/2"  
Load Rating: 100 lbs.\*  
Touch Release Feature

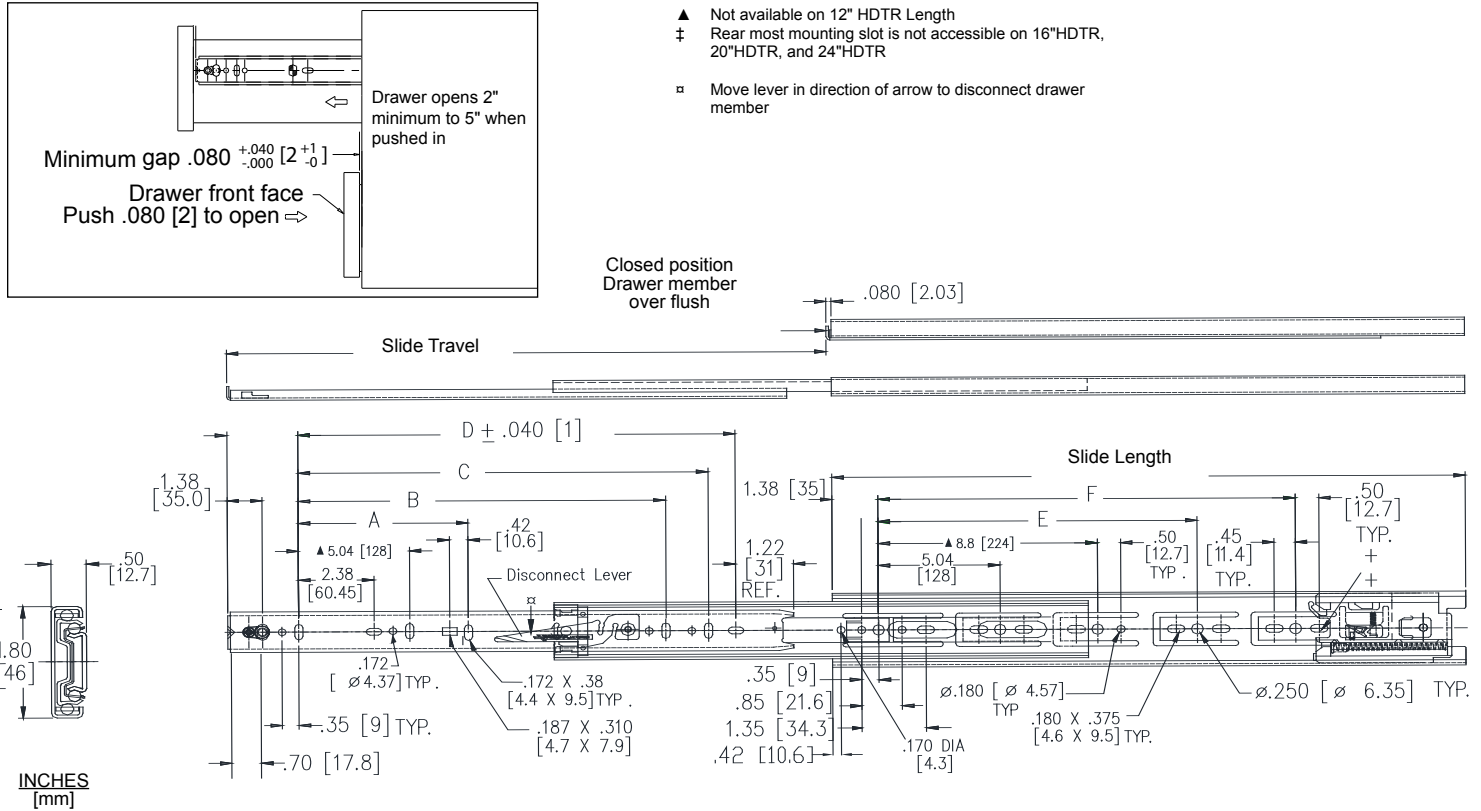

**Finish** Clear electroplate (C), black electroplate (CB), or white electrocoat (EW) finish (RoHS compliant)

**Load Rating** 100 lbs. [45.5 kg] per pair ♦

**Length** 12"-28" [300 mm-700 mm]

**Hardware** Flat head 6 mm Euro System screw or #8 pan head screw

**Side Space** .50" (+ .031-0.00) [12.7 mm] (+ 0.8-0.0)

**Travel** Full extension

**Height** 1.80" [45.7 mm]

**Disconnect** Handed lever disconnect

**Mounting** Side, optional rear face frame brackets

**Features** Drawer member vertical cam adjustment. Front face frame hole for Face Frame Installations

**Ball Bearings** C and CB finish: Steel  
EW Finish: Acetal polymer in drawer

Part Number	Slide Length	3832ETR Travel	A	B	C	D	E	F
3832-E12TR 3832-E12HDTR	11.81 [300]	12.00 [305]				7.58 [192]		
3832-E14TR 3832-E14HDTR	13.78 [350]	14.00 [356]				9.55 [242]		
3832-E16TR 3832-E16HDTR	15.75 [400]	16.00 [406]				11.51 [292]	11.34 [288]	
3832-E18TR 3832-E18HDTR	17.72 [450]	18.00 [457]		12.60 [320]		13.48 [342]	12.60 [320]	
3832-E20TR 3832-E20HDTR	19.69 [500]	20.00 [508]		12.60 [320]		15.45 [392]	15.12 [384]	
3832-E22TR 3832-E22HDTR	21.65 [550]	22.00 [559]	8.82 [224]	16.38 [416]		17.42 [442]	16.38 [416]	
3832-E24TR 3832-E24HDTR	23.62 [600]	24.00 [610]	8.82 [224]	16.38 [416]		19.39 [492]	13.86 [352]	18.90 [480]
3832-E26TR 3832-E26HDTR	25.59 [650]	26.00 [660]	8.82 [224]	16.38 [416]	20.16 [512]	21.36 [542]	13.86 [352]	20.16 [512]
3832-E28TR 3832-E28HDTR	27.56 [700]	28.00 [711]	8.82 [224]	16.38 [416]	20.16 [512]	23.33 [592]	13.86 [352]	21.42 [544]

\* A lateral file drawer is wider than it is deep.  
♦ Load rating based on 22" slides mounted in a 24" wide drawer cycled 50,000 times.  
**NOTE:** • Drawer width should not exceed slide length.

**Drawer Box Preparation**

1. Drawer box width should not exceed slide length.
2. Slides will not function properly if side space is less than .50" [12.7 mm]. For optimum performance, construct drawer 1-1/16" [27.0 mm] smaller than cabinet opening.

**Overlay Mounting**

1. Cabinet member installation:
  - Conventional mounting, See Figure 1.
  - 32 mm system mounting, see Figure 2.

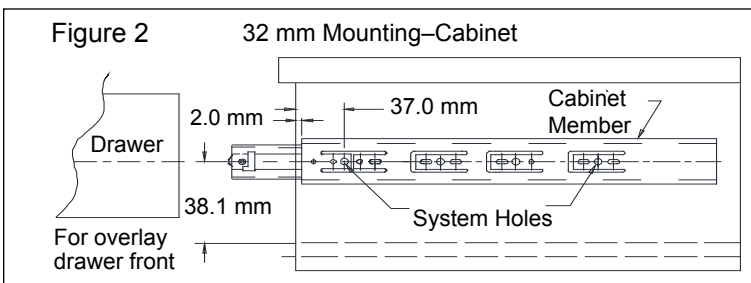
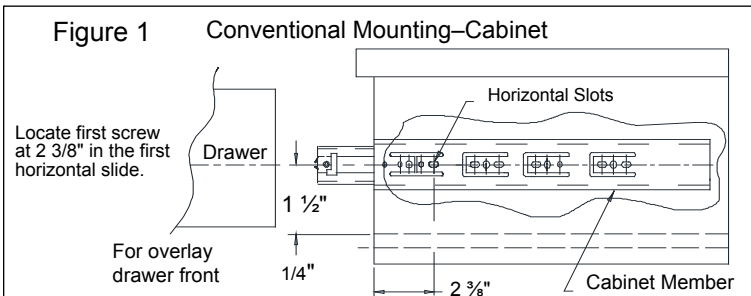

2. Use only the 32 mm system holes or the wood screw holes located at the tip of the breathing tabs. Do not use any other holes on the cabinet member for mounting (Figure 3).

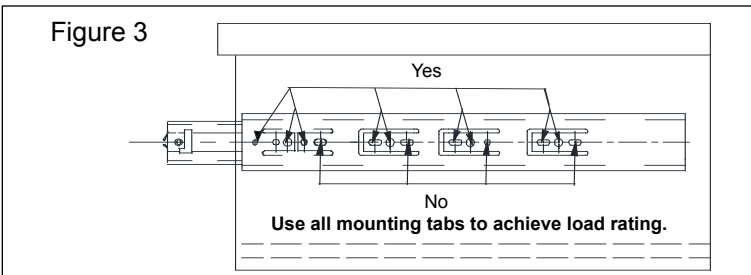

**Inset Mounting Instructions**

1. Mount the cabinet member .080" [2 mm] plus drawer front panel thickness back from the front of the cabinet.
2. Mount the drawer member flush to the back surface of the drawer front panel.

**Drawer Member Installation**

- See figure 4 for drawer member setback
- Install the drawer member with a screw through the cam adjuster and a screw through the hole or slot at the rear (Figure 5).

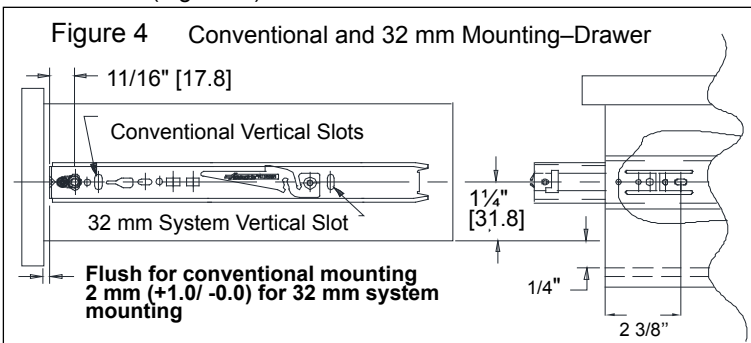

1. Make sure the ball bearing retainers in the cabinet side are fully forward. Install drawer into cabinet. Close the drawer.
2. For cam adjustment, open drawer and rotate the cam with a Phillips or Pozi screwdriver to vertically position the drawer in relation to the cabinet.

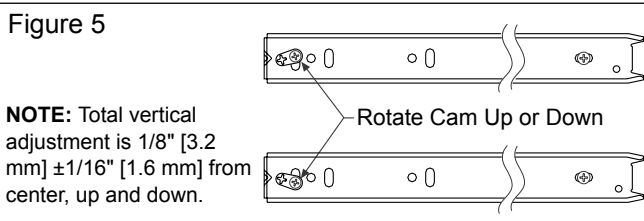

Install additional set screws to secure.

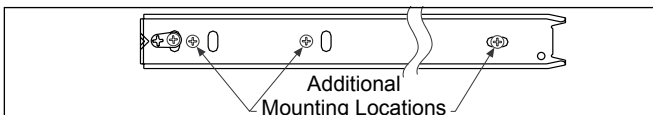

**Slide Ordering Instructions**

Complete your slide order for Accuride models 3832ETR and 3832EHDTR by specifying the following:

50 pair C 3832 E18 HDTR P  
50 Pair C 3832 E18 TR D\*

Total Required Slides \_\_\_\_\_  
Slide Finish \_\_\_\_\_  
Slide Model \_\_\_\_\_  
Slide Length \_\_\_\_\_  
Push Close/Open \_\_\_\_\_  
Polybag Packaging \_\_\_\_\_

\*D-Pack only for 3832ETR

**Optional Rear Face Frame Brackets**

Optional rear face frame brackets available, for rear face frame installations. See Rear Face Frame Conversion Kit technical sheet part number 4180-0758-XE for models 3832ETR and 3832EHDTR.

**Packaging**

**Distributor (D) Pack:** All lengths are packaged 10 pair per box. Polybag includes one pair of slides with mounting screws (3832ETR only).

**Bulk (P) Pack:** All lengths are packaged 10 pair per box. Slides and screws are ordered and packaged separately (3832ETR and 3832EHDTR).

**Specifications**

Slide members and ball retainers: Cold rolled steel  
Ball bearings: Carburized steel/acetal polymer  
RoHS compliant

**NOTE:** Specifications, materials, prices, terms, and delivery are subject to change without notice.



ACCURIDE INTERNATIONAL INC.

12311 Shoemaker Avenue  
Santa Fe Springs, CA 90670

TEL (562) 903-0200

FAX (562) 903-0208

www.accuride.com

Manufacturing, Engineering, and Sales

United States • Germany • Japan • Mexico • United Kingdom • China

Copyright © 2017 Accuride International Inc. 3700-9503(1178)-R4-0817