

Accuride[®] FLIPPER & POCKET DOOR SOLUTIONS

Turn to Accuride as your source of premium movement solutions for pocket and flipper doors.

With Accuride, you get solutions:

- For openings from 24" - 48" wide and 36" - 78" tall
- For vertical and horizontal doors
- With load capacities from 25 to 75 lbs.
- With optional features, such as soft-close and self-aligned movement
- RoHS compliance
- Accompanied by a limited lifetime warranty



CB 1321 Pro Pocket shown



MODELS

117

For Small Doors

123/1234

For Small Doors

1321 Pro Pocket

For Midsize Doors

1332/1432 Anti-Rak System

For Tall or Wide Doors

1145

For Wide Doors

1155 Easy-Down[®]

For Wide Doors



Vertical



Horizontal

117

For Small Doors

- Supports loads up to 25 lbs.
- For doors up to 24" wide x 36" tall
- Optional hold-out detent
- Silenced movement
- Available in clear zinc (C) and black (CB) finishes
- **Vertically or horizontally mounted**

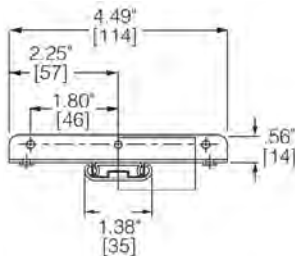

117 shown

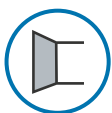

Vertical



Horizontal

123/1234

For Midsize Doors

- Supports loads up to 30 lbs.
- For doors up to 42" tall x 24" wide
- Features self-aligning movement
- Available in black (CB) finish
- 123 includes 35mm hinges
- 1234 hinges purchased separately
- **Vertically or horizontally mounted**

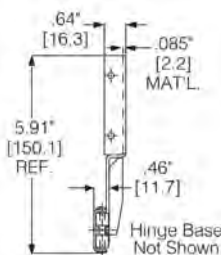

1234 shown

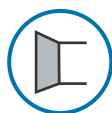

Vertical



Horizontal

1321 Pro Pocket

For Midsize Doors

- Supports loads up to 30 lbs.
- For doors up to 24" wide x 42" tall
- Easy to install
- Supports inset and ¾ full-overlay designs
- "Auto Open" ensures doors extend fully to prevent door scuffs
- Available in black (CB) finish
- **Vertically or horizontally mounted***

* Mounted with brackets provided by Accuride. Brackets attach to the top and bottom of the cabinet when installed vertically, and to side walls when installed horizontally.

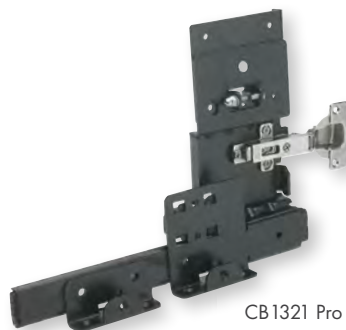
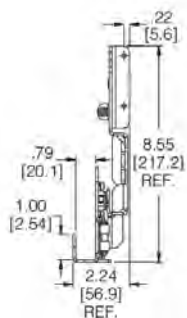

CB1321 Pro Pocket shown





Vertical

1332/1432

For Tall or Wide Doors

- Supports loads up to 75 lbs.
- For doors up to 78" tall x 26" wide
- Features advanced Anti-Rak stabilizer system
- Includes self-aligning movement
- Available in black (CB) finish
- Includes hold-out detent
- **Vertically mounted**

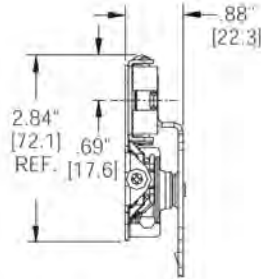

1332 shown



Horizontal

1145

For Wide Doors

- Supports loads up to 30 lbs.
- For doors up to 36" wide
- Available in clear zinc (C) and black (CB) finishes
- Available with steel or polymer ball bearings
- Includes pin hinge
- **Horizontally mounted**

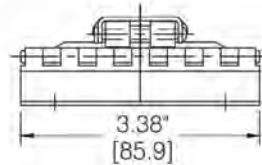

1145 shown



Horizontal

1155 Easy-Down®

For Wide Doors



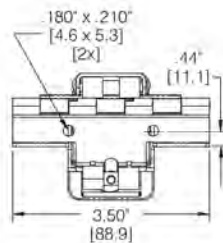













- Supports loads up to 30 lbs.
- For doors up to 48" wide
- Includes Easy-Down® feature that brings doors to a smooth and soft close.
- Available in clear zinc (C) and black (CB) finishes
- **Horizontally mounted**



1155 shown



Flipper & Pocket Door Slides Guide

Model	Door Fit	Mounting Options	Maximum Dimensions			
117	 Inset	 Vertical  Horizontal	Weight 25 lbs.	Height 36"	Width 24"	Thickness 3/4" ⁺
123 with hinge 1234 without hinge	 Partial Overlay	 Vertical  Horizontal	Weight 30 lbs.	Height 42"	Width 24"	Thickness 13/16" ⁺⁺
1321 Pro-pocket	 Inset  Full Overlay	 Vertical*  Horizontal*	Weight 30 lbs.	Height 42"	Width 24"	Thickness 3/4" Full Overlay 1-1/2" Inset
1332 with hinge 1432 without hinge	 Inset  Partial Overlay	 Vertical	Weight 75 lbs.	Height 78" ^{**}	Width 26"	Thickness 13/16"
1145 Flipper® Door	 Over the Top	 Horizontal	Weight 30 lbs.	Height 36"		Thickness 3/4"
1155 Flipper® Door with Easy-Down	 Over the Top	 Horizontal	Weight 30 lbs.	Height 48"		Thickness 3/4"



- + Varies depending on hinge used.
- ++ Becomes 1-1/4" when using 40 mm cup hinge.
- * Mounted with brackets provided by Accuride. Brackets attach to the top and bottom of the cabinet when installed vertically, or to side walls when installed horizontally.
- ** For doors above 36", consult data sheet for information on additional hinges and carrier strips.



Authorized Distributor



12311 Shoemaker Avenue
Santa Fe Springs, CA 90670
562.903.0200 • fax: 562.903.0208

www.accuride.com

© 2021 Accuride International Inc. SS-Flipper&PocketDoors-0321



Accuride printed materials are printed with soy-based inks. Printed on paper that contains recycled materials and conforms to the latest sustainable arboriculture guidelines.

Follow us:

